

# Real Application Cluster 11g

## No news, good news?

Ingemar Jansson Haverstad

[ingemar@oraklet.no](mailto:ingemar@oraklet.no)

[www.oraklet.no/foredrag](http://www.oraklet.no/foredrag)

Version 0.99  
01.04.2008

**ORACLE**  
Certified Professional

# No news, good news?

## 1 Oracle 11g Database New Features

### 1.5 Clustering

#### 1.5.1 Oracle Real Application Clusters Ease-of-Use

1.5.1.1 Enhanced Oracle RAC Monitoring and Diagnostics in Enterprise Manager

1.5.1.2 Enhanced Oracle Real Application Clusters Configuration Assistants

1.5.1.3 OCI Runtime Connection Load Balancing

1.5.1.4 Parallel Execution for Oracle Real Application Clusters

1.5.1.5 Support for Distributed Transactions in an Oracle RAC Environment

# Hva skal man velge?

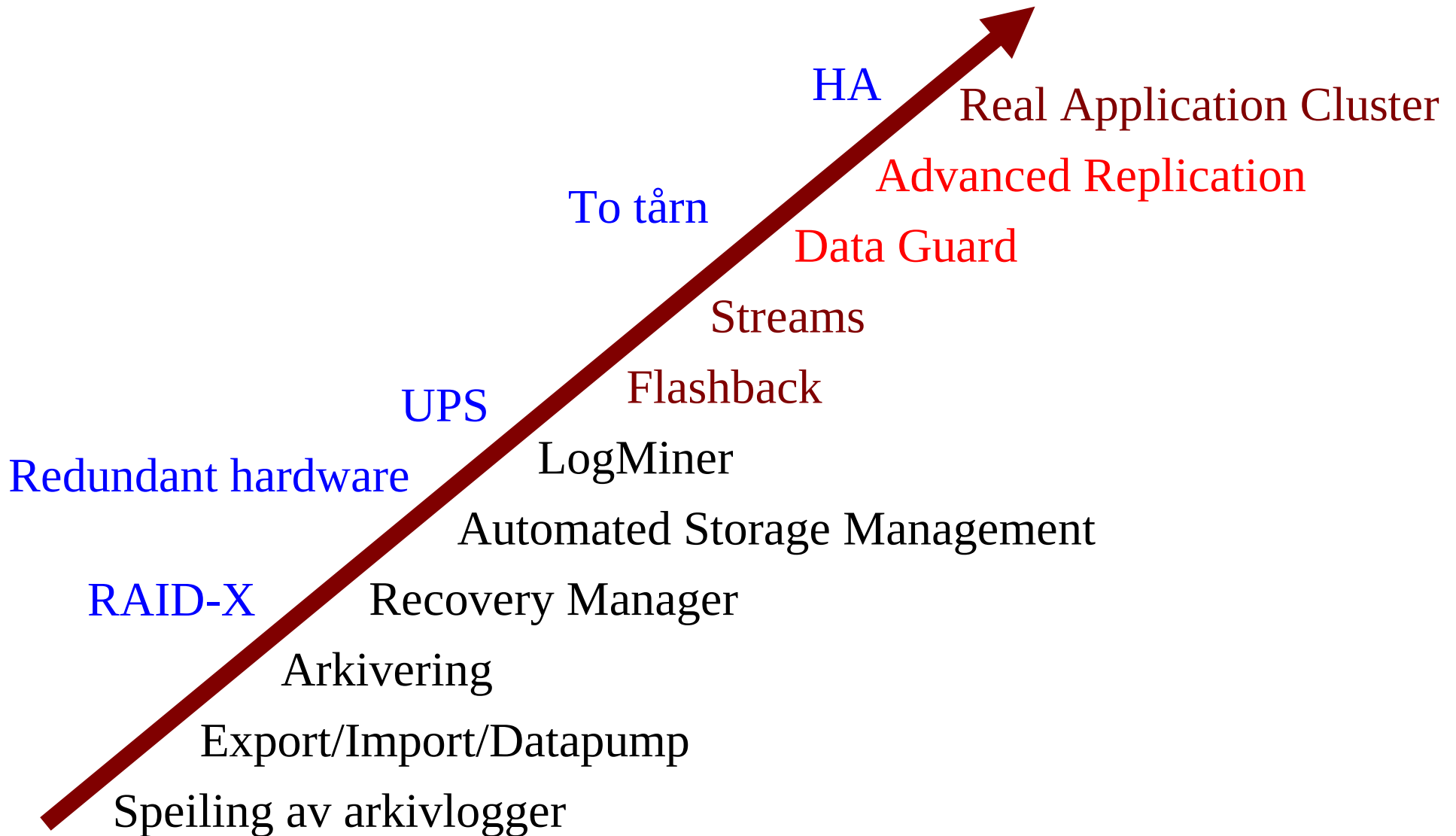

# Hva skal man velge?

**To tårn!**

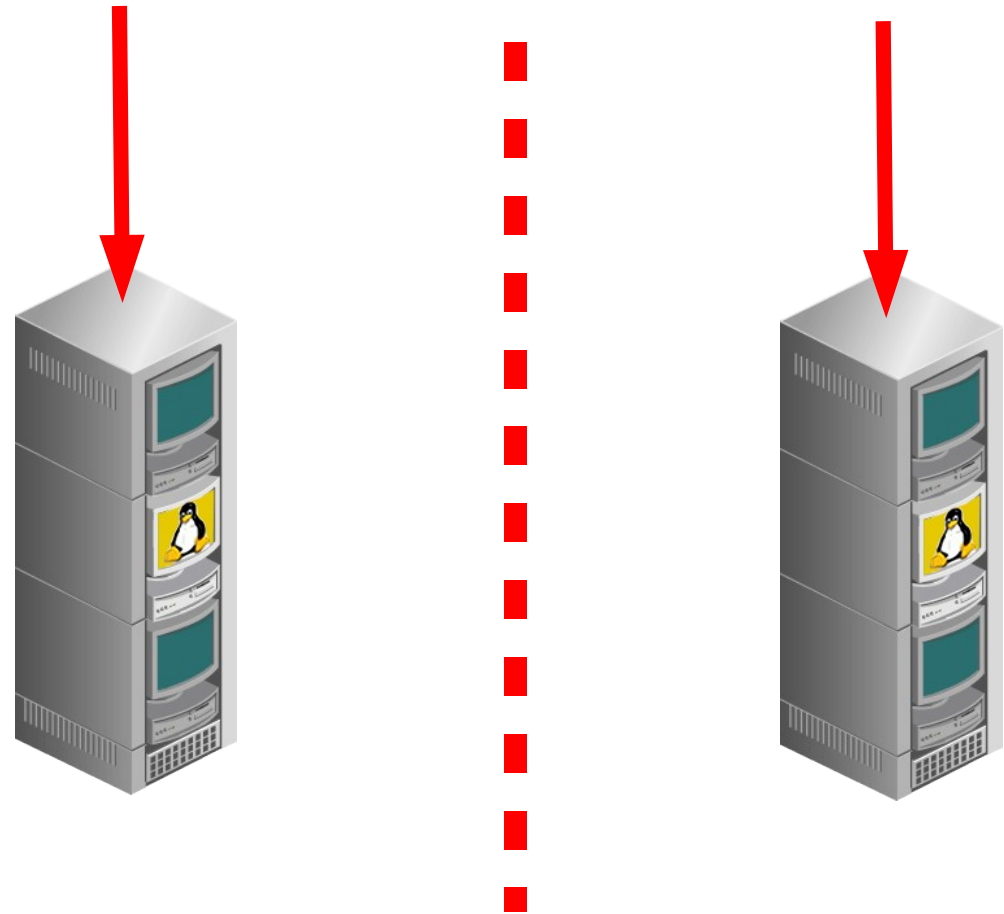

# Flashback Database

- «Flashback Database» er velegnet ved oppgradering av applikasjonen.
- Kan angi hvor lenge data skal lagres.
- «Flashback» tilbake går hurtig.

```
SQL> STARTUP MOUNT;  
SQL> ALTER DATABASE FLASHBACK ON;
```

## Oppgrader...

```
SQL> FLASHBACK DATABASE TO TIME  
      TO_TIMESTAMP('2003-04-04 14:00:00', 'YYYY-MM-DD HH:MI:SS');
```

```
RMAN> FLASHBACK DATABASE TO TIME (SYSDATE-1/24);
```

**ORA-00600 ...**

# Linux eller Unix?

## Linux

- 32-bit og 64-bit
- Fragmentert støtte
- 2-6 års kompetanse
- Stor volum
- Hyppige endringer

## Unix

- 64-bit
- Proprietær støtte
- 2-26 års kompetanse
- Utprøvd
- Små endringer

# RAC: Sikkerhet og skalering

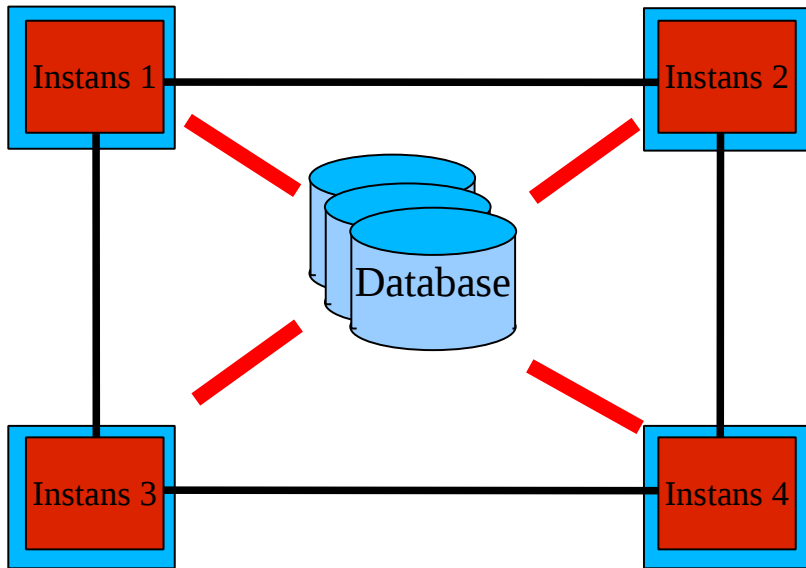

VPAR/LPAR

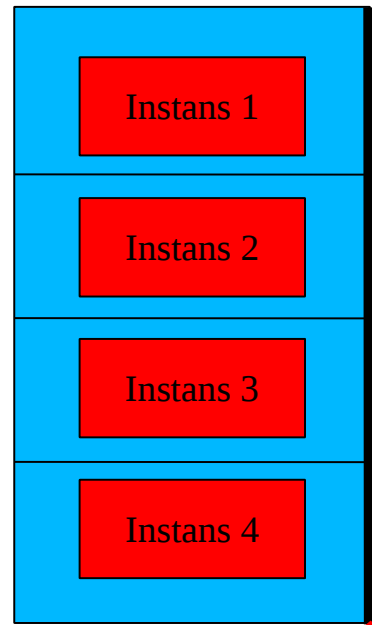

Blades

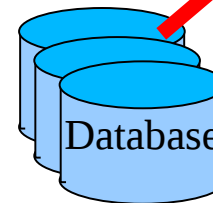
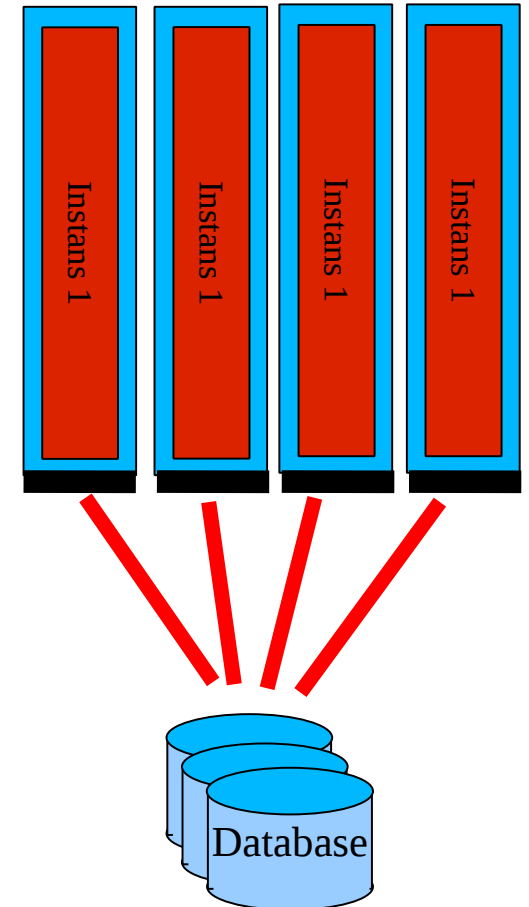

# Horizontal vs. Vertikal

## Horizontal

- Lavere innkjøpskostnad
- Lisensiering/CPU
- Pris/ytelse
- Trenger ytterligere
  - Strøm
  - Kjøling
  - Plass
  - Installasjon
  - Support
- Skalerbar kun via RAC
- System Interconnect
  - Høy «Latency»
  - Lav båndbredde



**Sun Fire x4450**



## Diagonal



**Sun Sparc M5000**

## Vertikal

- Høy innkjøpskostnad
- Fleksibel
- Konsolidering
- Dynamiske domener
- **RAS**
  - Pålitelighet
  - Tilgjengelighet
  - Sikkerhet
- Skalerbar
- Bedre utnyttelse
- System Interconnect
  - Lav «Latency»
  - Høy båndbredde



**Sun Sparc M9000**

# RAC versus Data Guard



## Oracle RAC

2 x Sun Enterprise M4000

- 2 x 2.15 Ghz Dual Core SPARC VI
- 16 GB
- 2 Dynamic System Domains
- 2 x 146GB SAS Disks

Hardware kostnad:

**542.568 NOK**

+ Support + Interconnect

2 x 2 x 0.75 EE License

- RAC lisens ((2 x 2) x 0.75)  
x 113. 100 NOK

Oracle Software kostnad:

**1.013.000 NOK**

+ Support + Service + Upgrade

**Total Cost: 1.556.000 NOK**

## Oracle Data Guard

2 x Sun Enterprise M4000

- 2 x 2.15 Ghz Dual Core VI
- 16 GB
- 2 Dynamic System Domains
- 2 x 146GB SAS Disks

Hardware kostnad:

**542.568 NOK**

+ Support + Interconnect

2 x 2 x 0.75 EE License

- Data Guard lisens ((2 x 2) x 0.75)  
x 28.000 NOK

Oracle Software kostnad:

**763.000 NOK**

+ Support + Service + Upgrade

**Total Cost: 1.306.000 NOK**

# Data Guard og/eller RAC?

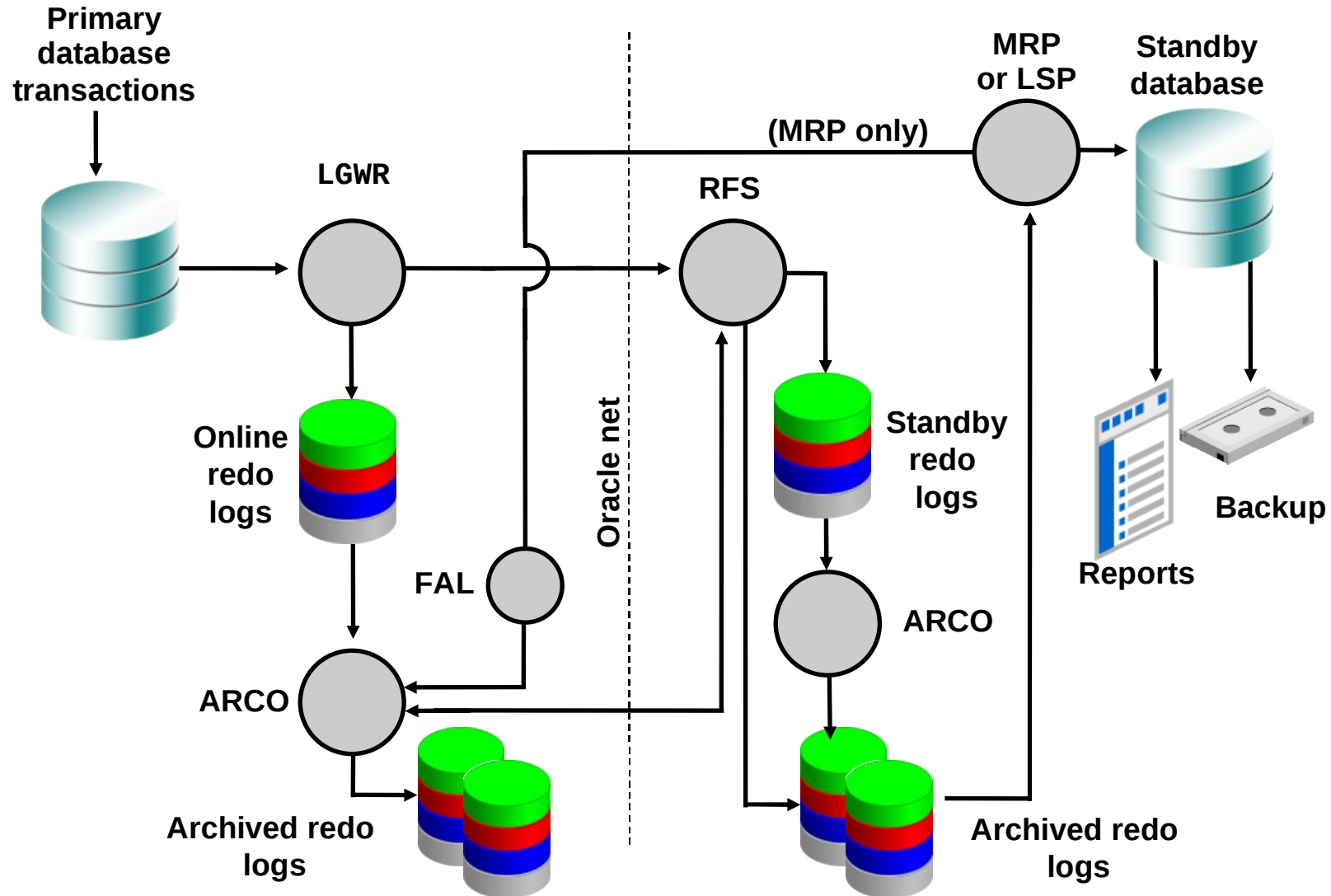





# Eksempel på løsning

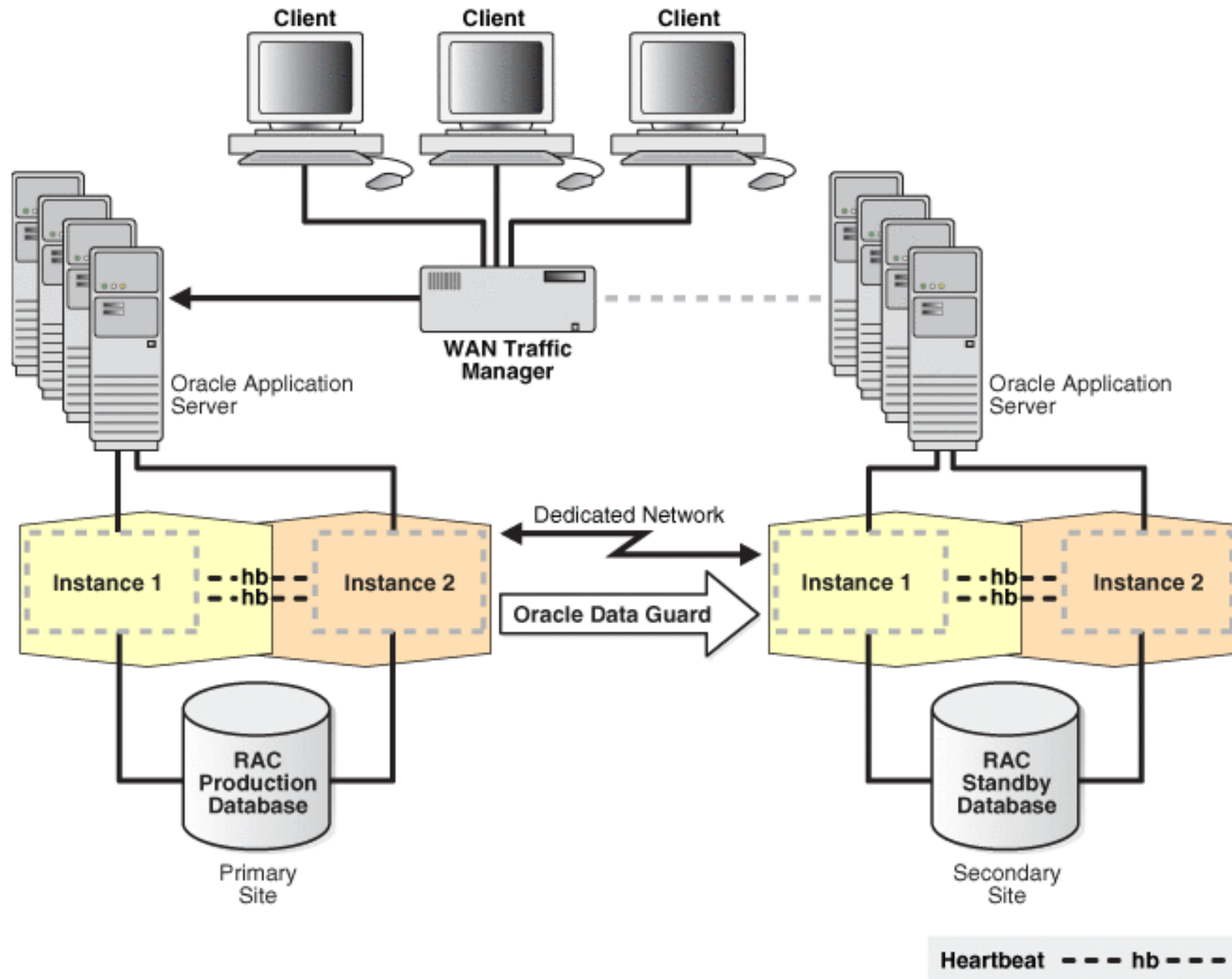

# Hva hvis uhellet skjer?

## Uhell

## MAA

## Teknikk

▪ Server krasj	Ikke nede tid	Real Application Cluster (RAC)
▪ Lagrings media	Ikke nede tid	Automatic Storage Management (ASM)
▪ Menneskelig svikt < 30 minutter		Flashback
▪ Korrupt data	Ikke nede tid < 30 sekunder	HARD* Data Guard
▪ Datarom svikt	< 30 sekunder	Data Guard

\* Hardware Assisted Resilient Storage

# Hvordan håndtere planlagte stopp?

15

## Situasjon

## MAA

## Teknikk

▪ System oppgradering	Ikke nede tid	Real Application Cluster (RAC)
▪ Klynge oppgradering	Sekunder til 5 minutter	Data Guard
▪ Migrering av data	Ikke nede tid	Automatic Storage Management (ASM)
▪ Database oppgradering	Sekunder til 5 minutter	Data Guard (logisk)
▪ Platform migrering	Minutter til mange timer	Transportable database, Streams

# MMA

## Maximum Availability Architecture

Oracles **Maximum Availability Architecture (MAA)** tilbyr ferdigintegreerte og velutprøvde teknologier, støttet av mange års erfaring når det gjelder tekniske løsninger for våre kunder.

Utgivelsen av **Oracle Database 11g** medfører, at du nå kan benytte deg av revolusjonerende nye teknologier for økt tilgjengelighet og databeskyttelse – som effektivt maksimerer data- og programtilgjengeligheten.

# MAA - Hvor skal man begynne?

Browser interface showing the Oracle Technology Network website. The address bar displays `http://www.oracle.com/technology/index.htm`. The search bar contains the text "MAA", which is highlighted by a red box and labeled "secure search - MAA" with a red arrow pointing to it.

The page header includes the Oracle logo and "TECHNOLOGY NETWORK". The user is logged in as "Ingemar Jansson D..." with options for "Sign Out" and "Account".

The main navigation menu includes: Getting Started, Downloads, Documentation, Forums, Articles, Sample Code, and Tutorials.

The left sidebar lists categories: PRODUCTS (Database, Middleware, Developer Tools, Enterprise Management, Applications Technology, Extensions and Plugins, Products A-Z), TECHNOLOGIES (BI & Data Warehousing, Embedded, Java, Linux, .NET, PHP, Security, Service-Oriented Architecture, Windows Server System, Technologies A-Z), and COMMUNITY.

The main content area features:

- RECENTLY POSTED:** Oracle OpenWorld 2007 Keynote Replays. Missed Oracle OpenWorld 2007? Watch keynotes by Larry Ellison, Charles Phillips, Thomas Kurian, and other speakers on demand. (Also, read Oracle OpenWorld attendee blogs, view attendee photos, and more.)
- FEATURED DOWNLOADS:**
  - Oracle Database 11g Release 1
  - Oracle VM
  - Oracle Coherence
  - Oracle JDeveloper 11g Tech Preview 2 Free product
  - Oracle SQL Developer Free product
  - Oracle Database XE Free product
- OTN Semantic Web Beta** | [click here](#)
- BLOGS**

The footer shows "Fullført" and a timestamp: "posted 11/16/07 16:54:07 GMT - Tags:".

# Oracle Technology Network

The screenshot shows a web browser window with the Oracle Technology Network search results for the query 'MAA'. The browser's address bar shows the URL 'http://search.oracle.com/search/search?defal'. The Oracle logo is visible in the top left, and navigation links like 'ORACLE.COM', 'TECHNOLOGY NETWORK', 'PARTNERS', 'STORE', and 'SUPPORT' are in the top right. The search results section shows 'Results 1 - 10 of about 106 matches for MAA.' A red arrow points to the first result, 'Oracle Maximum Availability Architecture (MAA)', which is a text-based document. Below it is a PDF document titled 'MAA Setup - RAC Primary & RAC Physical Standby'. The browser's status bar at the bottom shows 'Fullført'.

File Rediger Vis Historikk Bokmerker Verktøy Hjelp

http://search.oracle.com/search/search?defal Google

Ingemar Jansson D...

ORACLE.COM TECHNOLOGY NETWORK PARTNERS STORE SUPPORT Welcom

ORACLE®

World

Revise search: In the section:

MAA Technology Network Refine Search

NEED ASSISTANCE?

Search Help

Products A to Z

Results 1 - 10 of about 106 matches for MAA.

Did you mean: maa

Oracle Maximum Availability Architecture (MAA)

Oracle Maximum Availability Architecture (MAA) is Oracle's best practices blueprint based on proven Oracle high availability technologies and recommendations. Oracle Maximum Availability Architecture  
<http://www.oracle.com/technology/deploy/availability/htdocs/maa.htm> - 83k

[PDF] MAA Setup - RAC Primary & RAC Physical Standby

MAA / Data Guard 10 g Setup Guide – Creating...Availability Architecture MAA / Data Guard 10 g Setup  
Guide...Availability Architecture MAA / Data Guard 10 g Setup  
[http://www.oracle.com/technology/deploy/availability/pdf/MAA\\_WP\\_10g\\_RACPrimaryRACPhysicalStandby.pdf](http://www.oracle.com/technology/deploy/availability/pdf/MAA_WP_10g_RACPrimaryRACPhysicalStandby.pdf) -  
187k - Apr 18,2007 CDT

Fullført

# Gode regler for høy tilgjengelighet

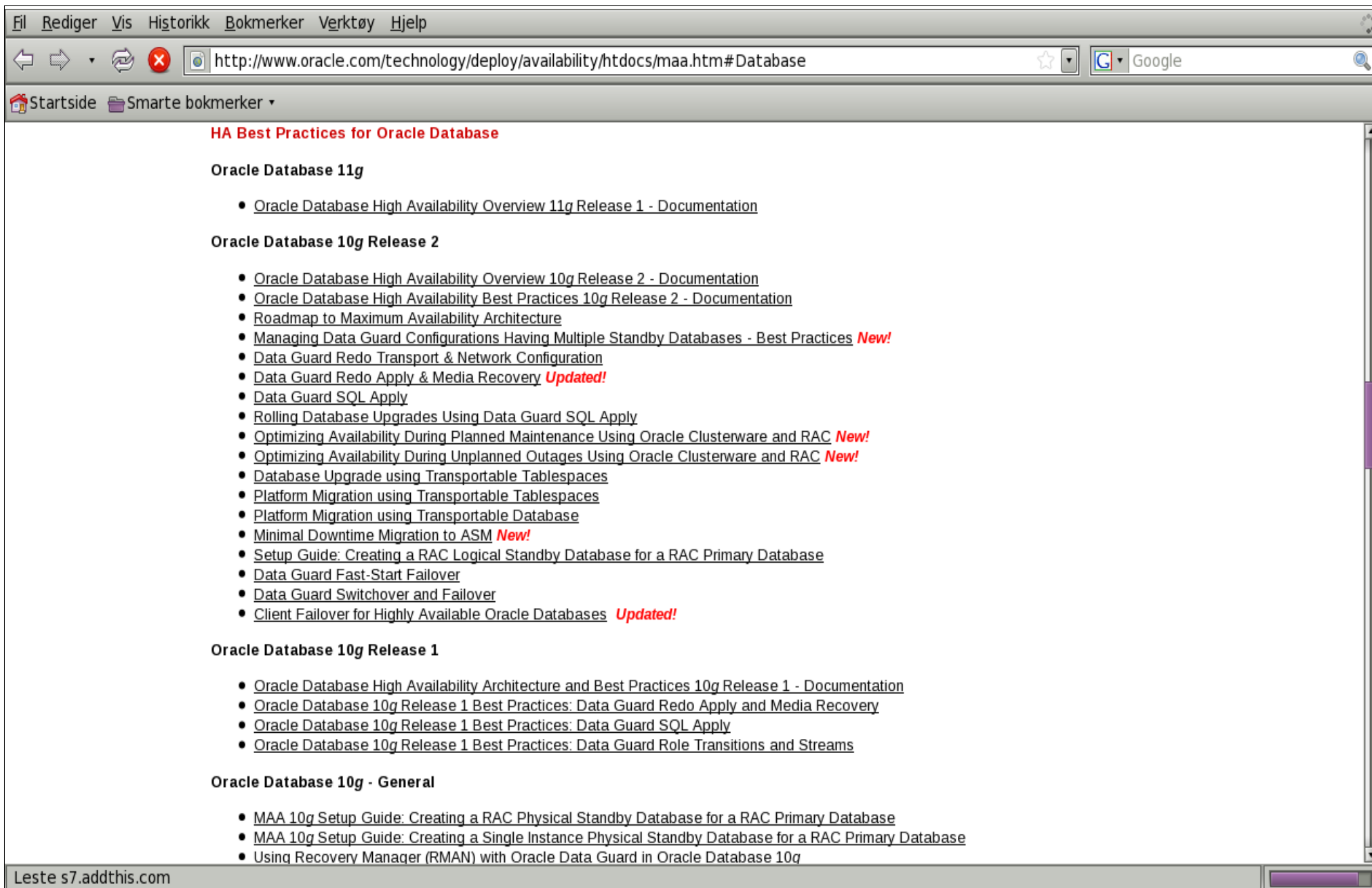

The screenshot shows a web browser window with the address bar containing the URL <http://www.oracle.com/technology/deploy/availability/htdocs/maa.htm#Database>. The browser's menu bar includes 'Fil', 'Rediger', 'Vis', 'Historikk', 'Bokmerker', 'Verktøy', and 'Hjelp'. The page content is titled 'HA Best Practices for Oracle Database' and is organized into sections for different Oracle Database versions.

**HA Best Practices for Oracle Database**

**Oracle Database 11g**

- [Oracle Database High Availability Overview 11g Release 1 - Documentation](#)

**Oracle Database 10g Release 2**

- [Oracle Database High Availability Overview 10g Release 2 - Documentation](#)
- [Oracle Database High Availability Best Practices 10g Release 2 - Documentation](#)
- [Roadmap to Maximum Availability Architecture](#)
- [Managing Data Guard Configurations Having Multiple Standby Databases - Best Practices \*New!\*](#)
- [Data Guard Redo Transport & Network Configuration](#)
- [Data Guard Redo Apply & Media Recovery \*Updated!\*](#)
- [Data Guard SQL Apply](#)
- [Rolling Database Upgrades Using Data Guard SQL Apply](#)
- [Optimizing Availability During Planned Maintenance Using Oracle Clusterware and RAC \*New!\*](#)
- [Optimizing Availability During Unplanned Outages Using Oracle Clusterware and RAC \*New!\*](#)
- [Database Upgrade using Transportable Tablespaces](#)
- [Platform Migration using Transportable Tablespaces](#)
- [Platform Migration using Transportable Database](#)
- [Minimal Downtime Migration to ASM \*New!\*](#)
- [Setup Guide: Creating a RAC Logical Standby Database for a RAC Primary Database](#)
- [Data Guard Fast-Start Failover](#)
- [Data Guard Switchover and Failover](#)
- [Client Failover for Highly Available Oracle Databases \*Updated!\*](#)

**Oracle Database 10g Release 1**

- [Oracle Database High Availability Architecture and Best Practices 10g Release 1 - Documentation](#)
- [Oracle Database 10g Release 1 Best Practices: Data Guard Redo Apply and Media Recovery](#)
- [Oracle Database 10g Release 1 Best Practices: Data Guard SQL Apply](#)
- [Oracle Database 10g Release 1 Best Practices: Data Guard Role Transitions and Streams](#)

**Oracle Database 10g - General**

- [MAA 10g Setup Guide: Creating a RAC Physical Standby Database for a RAC Primary Database](#)
- [MAA 10g Setup Guide: Creating a Single Instance Physical Standby Database for a RAC Primary Database](#)
- [Using Recovery Manager \(RMAN\) with Oracle Data Guard in Oracle Database 10g](#)

Leste s7.addthis.com

# Oracle Database 10g Release 2: Roadmap to Maximum Availability Architecture

*Oracle Maximum Availability Architecture White Paper  
April 2006*

Introduction .....	2
MAA Background .....	2
MAA Features.....	3
MAA Benefits .....	3
Minimizing Planned and Unplanned Downtime with MAA ....	4
A Roadmap for Using MAA Best Practice Publications ....	5
References .....	8

# Best Practices for Optimizing Availability During Planned Maintenance Using Oracle Clusterware and Oracle Real Application Clusters

*Oracle Maximum Availability Architecture White Paper  
September 2007*

Executive Summary .....	3
Prerequisites and Terminology.....	4
Scope .....	7
Availability .....	8
Best Practices .....	14
Appendix A: Enterprise Manager Grid Control.....	41
Appendix B: Oracle Software Reconfiguration after Cloning .....	41
Appendix C: Guidelines When an Interim Patch Changes the Persistent Data Storage.....	41
References .....	43

# Hva beskrives i dokumentet?

## Vedlikeholdsoppgaver:

Grid provisioning.

Hardware, BIOS, firmware, operating system oppgraderinger og rettelser.

Oracle Clusterware oppgraderinger og rettelser.

Aktive og rullerende RDBMS/ASM rettelser.

Ikke rullerende RDBMS/ASM rettelser.

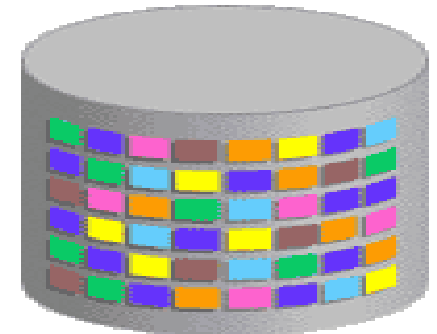

# Rettelser og oppgraderinger...

- Oracle Interim patches
- Oracle Merge patches
- Oracle Bundle patches
- Oracle Critical Patch Update (CPU) patches
- Oracle Patchsets
- Oracle Upgrades
- Operating system upgrades and patches



**Administrator**

Dokumentet beskriver:

Oracle10g 10.2.0.2 (patchset 1)

Oracle10g 10.2.0.3 (patchset 2)

Oracle10g 10.2.0.4 (patchset 3)

Oracle11g (online patching)

# Oppgradering av Clusterware

<u>Oppgave</u>	<u>Metode</u>	<u>Situasjon</u>
<ul style="list-style-type: none"> <li>Interim patches</li> </ul>	OPatch EM Grid	Enkeltfeil EM Grid
<ul style="list-style-type: none"> <li>Patch set</li> </ul>	OUI EM Grid	Fra 10.2.0.3 til 10.2.0.4
<ul style="list-style-type: none"> <li>Legge til node</li> </ul>	OUI EM Grid Kloning	Tilføye node til eksisterende klynge.

# MAA - RAC - Aktiv oppgradering?

## *Oracle10g*

```
$ opatch query -all /patch/6394981 | grep rolling  
Patch is a rolling patch: true
```

## *Oracle11g*

```
$ opatch query /patch/7405741 -is_online_patch  
Patch is a online patch: true
```

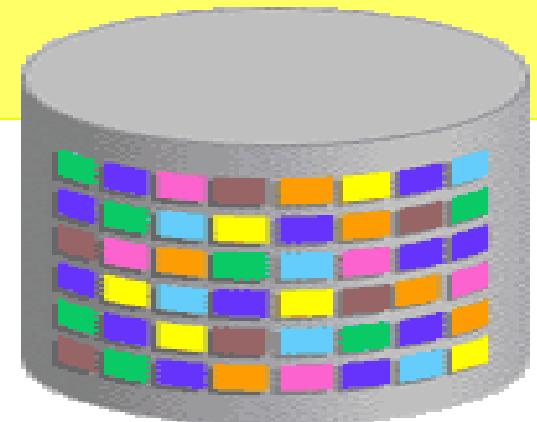

# MAA - Hurtig oppgradering

## `opatch -minimize_downtime`

Praksis for oppgradering av tidligere versjoner av *Oracle*:

1. Stoppe aktuelle programmer på alle nodene.
2. Installere rettelsene på alle nodene.
3. Starte aktuelle programmer på alle nodene.

I *Oracle 10.2* med *minimize\_downtime*, kan *opatch* brukes slik:

1. Stoppe en del av alle instansene (subset 1).
2. Installere rettelsene på disse nodene (subset 1).
3. Stoppe den andre delen av nodene (subset 2).
4. Starte nodene som er oppdatert (subset 1).
5. Installere rettelsene på den andre delen av nodene (subset 2).
6. Starte den andre delen av nodene (subset 2).

# MAA - Omlinking av Oracle kode

Noen ganger er det uklart om kode må linkes om etter at programmene er blitt oppdatert.

Som beste praksis bør koden da linkes om. Det finnes et egnet program for dette.

```
$ $ORACLE_HOME/bin/relink
usage: relink <parameter>
  parameters: all, oracle, network, client, client_sharedlib,
              interMedia, ctx, precomp, utilities, oemagent, ldap

$ $ORACLE_HOME/bin/relink oracle
- Linking Oracle
rm -f /oracle/product/11.1.0/db/rdbms/lib/oracle
gcc -o /oracle/product/11.1.0/db/rdbms/lib/oracle -L/oracle/product
/11.1.0/db/rdbms/lib/ -L/oracle/product/11.1.0/db/lib/ -L/oracle/pro
duct/11.1.0/db/lib/stubs -L/usr/lib -lirc -lipgo...
```

# MAA- Oppgradering av BIOS, firmware, server eller OS rettelse.

Stoppe og slå av tjenester på den første noden:

```
$ srvctl stop service -d RAC -s OLTP -i RAC1  
$ srvctl disable service -d RAC -s OLTP -i RAC1
```

Stoppe instansen kontrollert:

```
$ srvctl stop instance -d RAC -i RAC1 -o immediate
```

Stoppe og slå av Clusterware:

```
$ sudo $CRS_HOME/bin/crsctl stop crs  
$ sudo $CRS_HOME/bin/crsctl disable crs
```

Utfør endringen.

Slå på og starte Clusterware:

```
$ sudo $CRS_HOME/bin/crsctl enable crs  
$ sudo $CRS_HOME/bin/crsctl start crs
```

Slå på og starte tjenester:

```
$ srvctl enable service -d RAC -s OLTP -i RAC1  
$ srvctl start service -d RAC -s OLTP -i RAC1
```

# Kloning

```
[ora10g@xps product]$ cd /oracle/product  
  
[ora10g@xps product]$ sudo cp -pr 10.2.0.3/db 10.2.0.4  
  
[ora10g@xps product]$ diff -q -r 10.2.0.3/db 10.2.0.4/db  
  
[ora10g@xps product]$ cd 10.2.0.4/db/clone/bin  
/oracle/product/10.2.0.4/db/clone/bin  
  
[ora10g@xps product]$ perl ./clone.pl \  
    ORACLE_HOME=/oracle/product/10.2.0.4/db \  
    ORACLE_HOME_NAME=10gR2P2  
Starting Oracle Universal Installer...  
Install successful  
Link successful  
Setup successful  
The cloning of 10gR2P2 was successful.  
  
[ora10g@xps product]$ sudo /oracle/product/10.2.0.4/db/root.sh
```

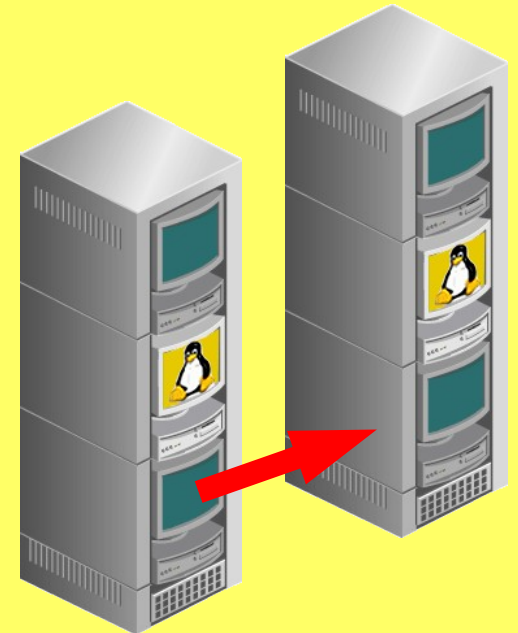

# MAA - Kloning RAC

```
# This should be run as root to ensure copy permissions/ownership
echo "Pre-clone copy started at `date`" | tee -a clone.log
cp -pr /oracle/product/10.2.0 /oracle/product/10.2.0.4
echo "Pre-clone copy ended at `date`" | tee -a clone.log
echo "Verification check started at `date`" | tee -a clone.log
diff -q -r /oracle/product/10.2.0 /oracle/product/10.2.0.4 | \
tee -a clone_diff.out
echo "Verification check ended at `date`" | tee -a clone.log
echo "Clone started at `date`" | tee -a clone.log

su - oracle -c
"perl /oracle/product/10.2.0.4/db/clone/bin/clone.pl
ORACLE_HOME=/oracle/product/10.2.0.4/db ORACLE_HOME_NAME=10gR2P2
'-O"CLUSTER_NODES={node1,node2,node3}"' '-O"LOCAL_NODE=node1"'

/oracle/product/10.2.0.4/db/root.sh << eof
/usr/local/bin
eof

echo "Clone ended at `date`" | tee -a clone.log
```

# Best Practices for Optimizing Availability During Unplanned Outages Using Oracle Clusterware and Oracle Real Application Clusters

*Oracle Maximum Availability Architecture White Paper  
March 2007*

Executive Summary .....	2
Prerequisites and Terms .....	4
Assessing Availability.....	4
Best Practices .....	10
Sample Configurations .....	14
Appendix A – The Project Environment .....	16
Appendix B – Results With and Without Best Practices..	21
Appendix C – Understanding MTTR.....	29
Appendix D – Detailed Component Availability .....	31
Appendix E – Listener Connection Rate Throttling.....	34
References .....	37

# MAA - Beste praksis – Clusterware og Real Application Cluster

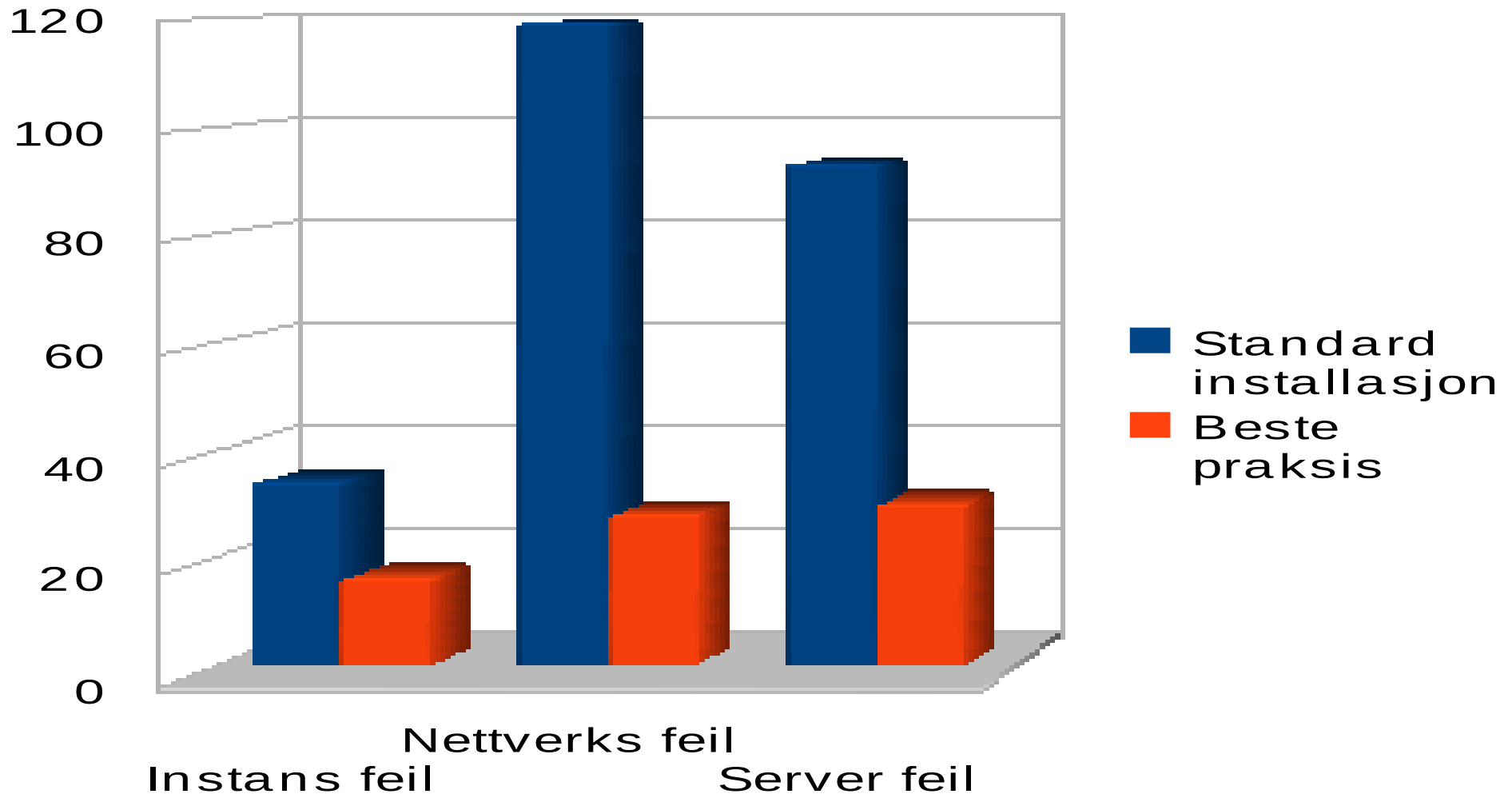

# MAA - Beregning av stopp

Angi antall sekunder innen instansen er oppe.

**Enterprise Edition:** `FAST_START_MTTR_TARGET`

**RAC:** `_FAST_START_INSTANCE_RECOVERY_TARGET`

```
SQL> ALTER SYSTEM SET _FAST_START_INSTANCE_RECOVERY_TARGET=5  
                        COMMENT='Gjenoppretting 5 sek. , IJH';
```

Doble antallet prosesser for gjenoppretting av transaksjoner.

```
SQL> ALTER SYSTEM SET FAST_START_PARALLEL_ROLLBACK=HIGH  
                        COMMENT='Transaksjonsgjenoppretting, IJH';
```

## Aktiver asynkron I/O

```
SQL> ALTER SYSTEM SET DISK_ASYNC_IO=TRUE  
                        COMMENT='Asynkron I/O, IJH';
```

# MAA - Login storm

## - Listener Connection Rate Throttling

```
LISTENER_STBDC18 =  
  (DESCRIPTION_LIST =  
    (DESCRIPTION =  
      (ADDRESS_LIST =  
        (ADDRESS =  
          (PROTOCOL = TCP)(HOST = stbdc18-vip)(PORT = 1521)  
          (RATE_LIMIT=YES) (QUEUESIZE=1024)(IP = FIRST)  
        )  
      )  
    )  
    (ADDRESS_LIST =  
      (ADDRESS =  
        (PROTOCOL = TCP)(HOST = 152.68.196.208)(PORT = 1521)  
        (IP = FIRST))  
      )  
    (ADDRESS_LIST =  
      (ADDRESS = (PROTOCOL = IPC)(KEY = EXTPROC))  
    )  
  )  
)
```

**CONNECTION\_RATE\_LISTENER\_STBDC18=100**



# OFA – Layout I

- Clusterware (CRS)
- ASM
- Databaser
- Listener

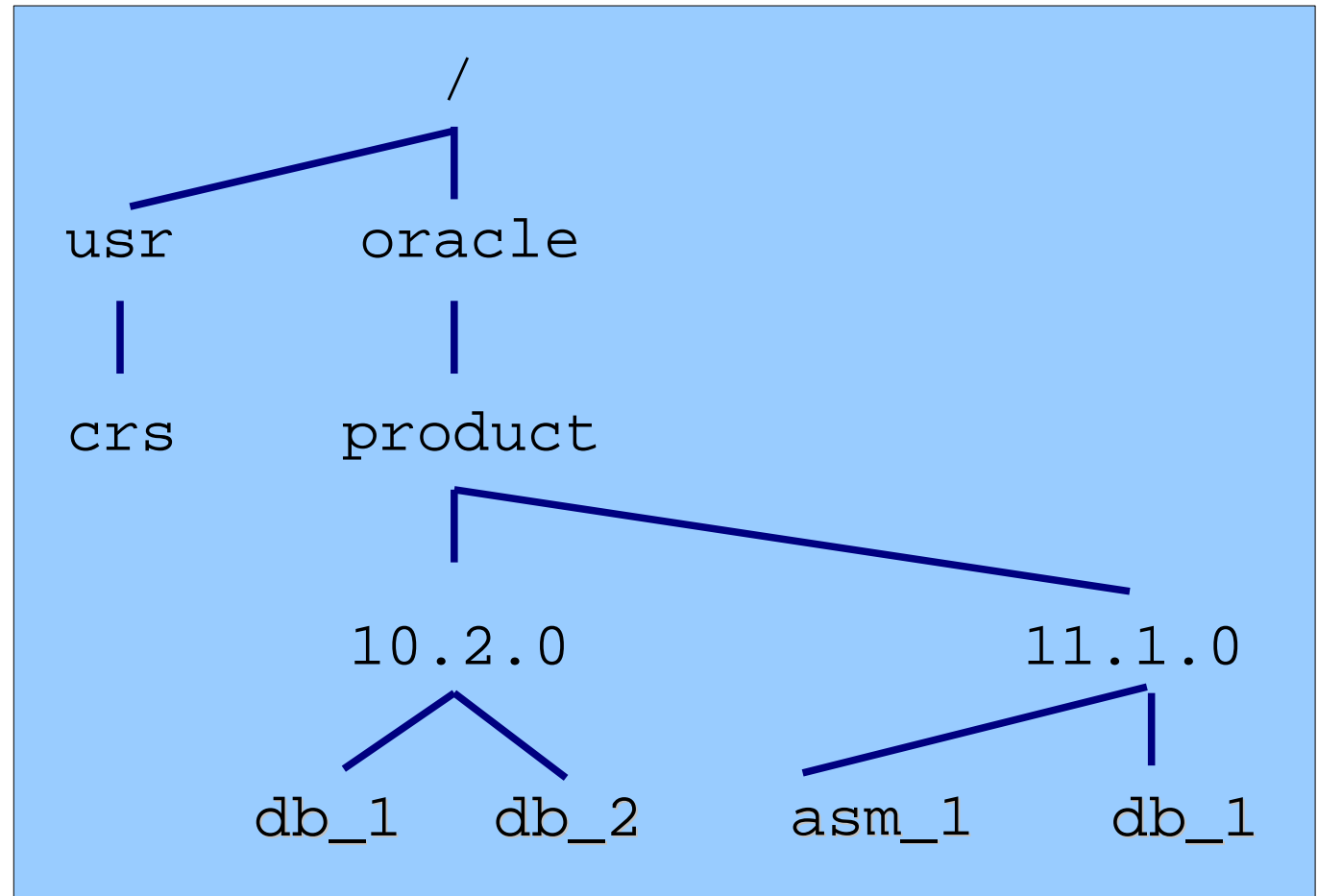

# OFA – Layout II

- Installasjon i forveien  
Flytte spfile, password fil, listener filer

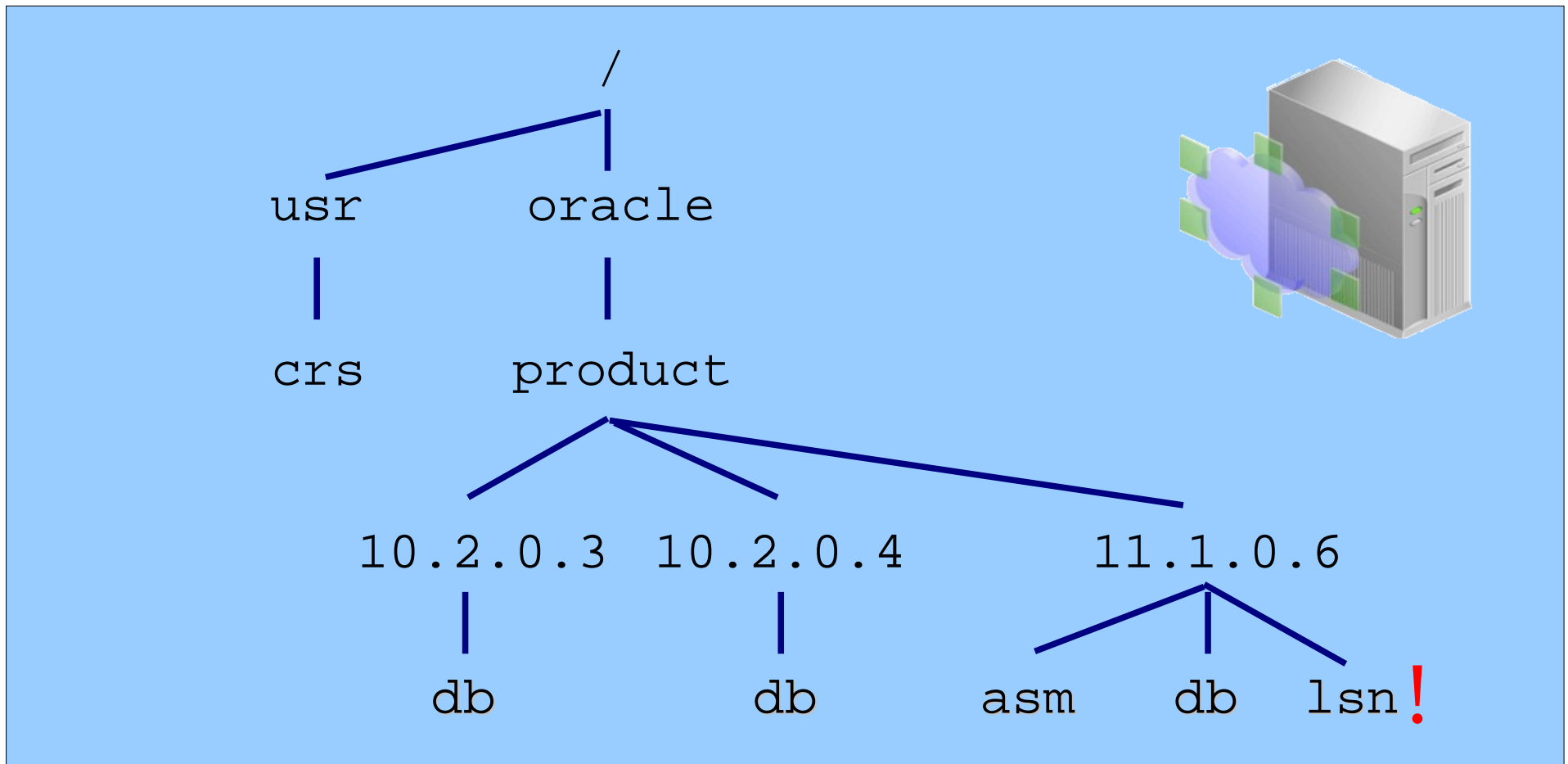

# Listener

- Benytte to porter: 1521 og 1526
- Installere listener i separat ORACLE\_HOME.
- Nyeste versjon av Oracle

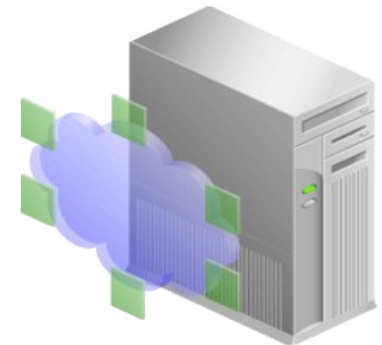
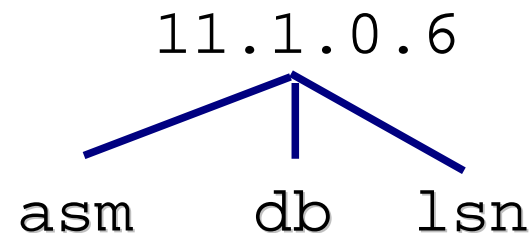

# Tilpasse SQL-Prompten

Bruker du også *SQL\*Plus* når du arbeider i Oracle?  
Da har jeg et tips til deg.

Det første jeg gjør når jeg arbeider i en ny database er å sette SQL-prompten. Da vises navnet du har logget inn med og instans navnet i prompten.

Variabelen *sqlprompt* defineres enten i filen *glogin* i katalogen *\$ORACLE\_HOME/sqlplus/admin* eller i lokal fil *login.sql*.

Arbeider du fra en klient kan også endringen utføres der.

```
SET sqlprompt "_USER'@'_CONNECT_IDENTIFIER SQL> "
```

Og resultatet blir:

```
$ sqlplus sh/password  
SH@RAC1 SQL>
```

# Testing

- **Hvor mye skal testes?**
  - Feilsituasjoner
  - Skalering
  - Oppgradering
  - Kompetanse
- **Hvilke metoder skal benyttes?**
- **Hvor mye får det koste?**



# Real Application Testing?

## Kostnad per CPU core:

Real Application Clusters - \$20 000 (113.000 NOK)

Data Guard - \$5 000 (28.000 NOK)

Partitioning - \$10 000 (56.000 NOK)

Real Application Testing (11g) - \$10 000 (56.000 NOK)

Kan flytte last fra 10.2.0.4 til 11g for å teste...



# Dokumentasjon

- **Hva skal dokumenteres?**
- **Kan noe av Oracles dokumentasjon (gjen)brukes?**  
`http://tahiti.oracle.com`
- **Metalink – knowledge browser**  
`http://metalink.oracle.com`
- **Hvem skal benytte dokumentasjonen?**
- **Hvordan skal dokumentasjonen utformes?**

# RAC og Data Guard SQL apply

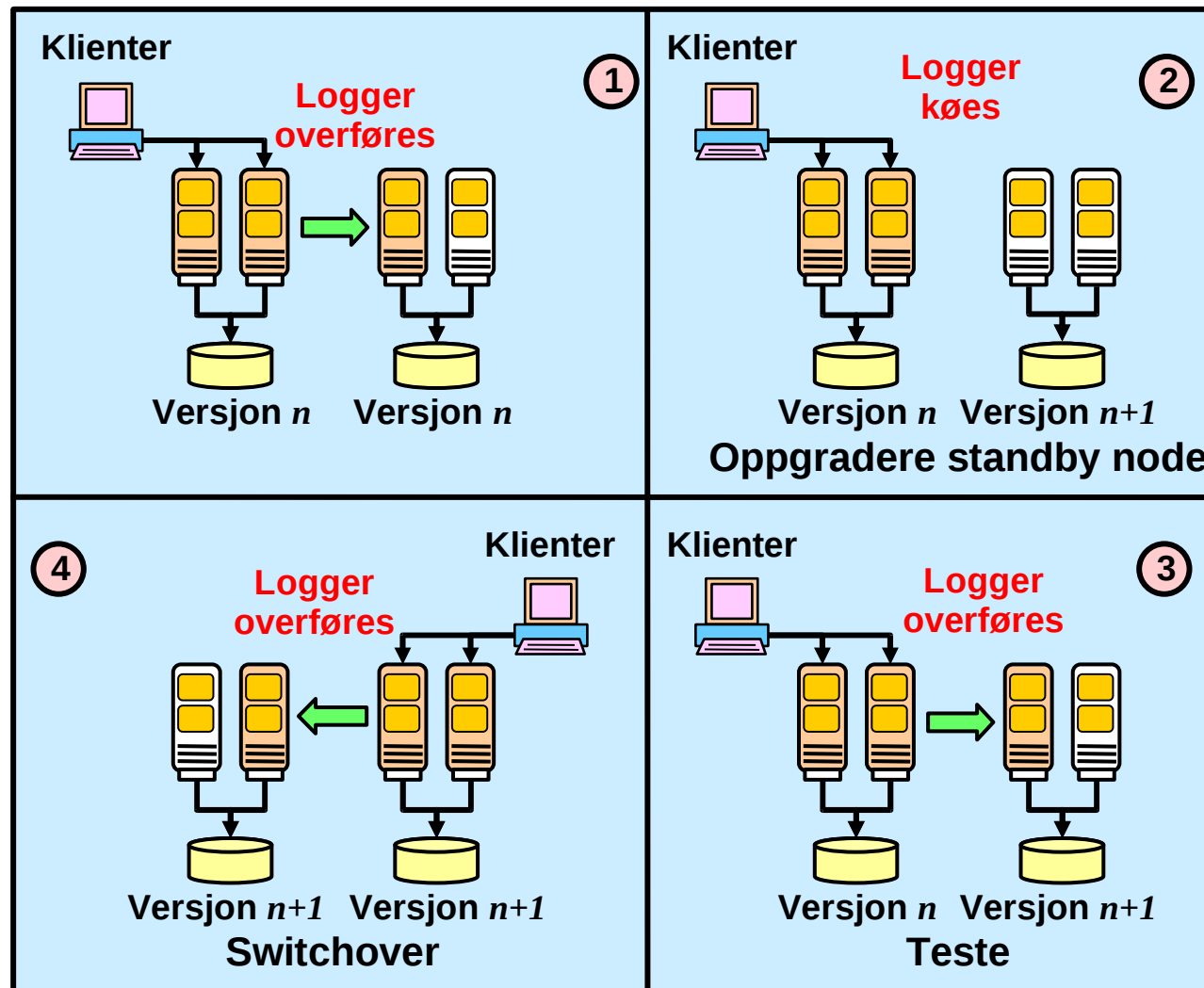

Patch set  
oppgraderinger

Hoved  
versjons  
oppgraderinger

Cluster  
program  
og  
Maskin  
oppgraderinger

# Oppgradering

- Oppgradere Clusterware først.
- Oppgradere listener.
- Oppgradere ASM
- Opprette ny ORACLE\_HOME
- Oppgradere databasen(e)
- Dokumentasjon på Metalink som beskriver rekkefølgen godt.

# ASM?

- Hvis du benytter ASM, prøv å benytt en **alternativ** teknologi for FLASHBACK\_RECOVERY\_AREA.
- Dette skal selvfølgelig også være et annet disksystem!

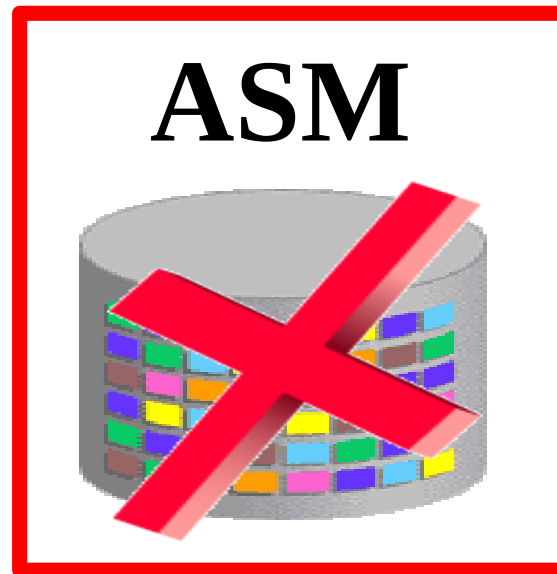

\* Oracle Cluster File System

# Referanser?

- **Finnes det relevante referanser?**
- **Er det aktuelt med samarbeide?**
- **Finnes det noen konfigurasjon fra <http://www.tpc.org> som kan benyttes?**

# Tidsplaner...

# Oracle Kurser

- **2 Day DBA**
- **Administration Workshop I**
- **Administration Workshop II**
- **New Features...**
- **Backup and Recovery**
- **Administering Real Application Cluster**
- **RAC Deployment Workshop**
- **Data Guard Administration**

**<http://www.oracle.com/no/education>**

# Konklusjon - MAA

- Beste praksis, relevant i mange situasjoner
- Godt oppdatert
- Gode eksempler
- Kunne vært enda bedre skrevet...

